

CPR MEDICAL DEVICES INC.

**OPERATING MANUAL
FOR
OXYLATOR[®] EMX
RESUSCITATION
AND
INHALATION SYSTEM**



Symbols used in the Operating Manual for the OXYLATOR[®] EMX
and/or on the OXYLATOR[®] EMX unit:

WARNING !



Do not use grease or oil!



Do not use near open flames
or while smoking!



Do not use a wrench!



Do not autoclave!



Oxygen Release Button



Serial Number



Inhalator Button



Caution! Warning!
Consult accompanying
documentation!

The OXYLATOR[®] EMX contains patented technology developed by
CPR Medical Devices Inc., 161 Don Park Road,
Markham, Ontario, L3R 1C2, Canada
U.S. Patent No. 5,230,330
Global patents and further U.S. patents pending

The OXYLATOR[®] EMX Operating Manual is published by:
CPR Medical Devices Inc., Vol. I, 1/2002
Applies to Series "H" (fourth character of serial number)

TABLE OF CONTENTS

	Page
Table of Contents -----	3
Section 1 --- Information for the User -----	4, 5
Section 2 --- Technical Description and Features -----	6, 7
OXYLATOR [®] EMX Components (Diagram) -----	8, 9
Section 3 --- Modes of Operation -----	10
Section 4 --- Operating Instructions -----	11
Section 5 --- Cleaning and Disinfecting -----	12, 13
Section 6 --- Maintenance -----	14
Section 7 --- Warranty -----	14
Section 8 --- Specifications -----	15



CAUTION: Federal (USA) law restricts this device to sale by or on the order of a physician.

CE
0120

SECTION 1...





INFORMATION FOR THE USER

Indication for Use:

The OXYLATOR[®] EMX is an oxygen powered resuscitator intended to provide emergency ventilatory support for individuals weighing more than 10 kg (22 pounds). Ventilation may be performed using a mask or an endotracheal tube.



Warnings:

- The OXYLATOR[®] EMX should be used only by individuals who have adequate training in CPR techniques and the operation of oxygen powered resuscitators.
- Do not use any type of one-way valve between the OXYLATOR[®] EMX and the patient; its use will cause the system to malfunction.
- Do not expose the OXYLATOR[®] EMX to MRI (magnetic resonance imaging) environments.
-  Do not use grease or oil on the OXYLATOR[®] EMX for any reason.
- Do not use the OXYLATOR[®] EMX in oxygen deficient atmospheres or near open flames. 
- Do not autoclave the OXYLATOR[®] EMX. 
- Ensure that the OXYLATOR[®] EMX is completely dry before exposing it to freezing conditions. Liquid or water in valves may cause them to malfunction in freezing conditions. See Section 5: Cleaning and Disinfecting, pages 12 & 13.
- Do not smoke while using the OXYLATOR[®] EMX or any other oxygen equipment. 
-  Do not use wrenches or any other tools on the OXYLATOR[®] EMX. Hand-tighten all parts including the hose while connecting or disconnecting it to the unit.
- Do not dismantle or attempt to remove any components other than those required for routine cleaning. Any tampering with the OXYLATOR[®] EMX may cause the unit to malfunction, and will automatically void the warranty.



Precautions:

- The OXYLATOR[®] EMX should be connected to a pressurized source supplying a minimum constant flow of 30 litres per minute and between 45 psig to 80 psig or 3.0 bar to 5.5 bar.

- When an operator observes an abnormally long inspiratory phase (greater than 2 seconds in adults and greater than 1 second in a child), the OXYLATOR[®] EMX should only be used in manual mode and the inspiratory phase restricted to approximately 2 seconds for an adult and 1 second for a child. See page 10, 1.

- When ventilating an intubated patient, higher pressure release settings may be required. Select a pressure setting of 30 cm H₂O to start and adjust if necessary.

- An audible, rapid clicking sound or buzzing sound and rapid movement of the tip of the main valve indicates airway obstruction. Clear the airway, and then resume the ventilation procedure.

- The OXYLATOR[®] EMX should be subjected to high level cold disinfection or boiling water after each patient use.

- Replace the filter after each patient use and/or if the valve becomes contaminated with vomitus during a CPR attempt.

- Please review and follow the instructions and observe the warnings in this manual before using the OXYLATOR[®] EMX

- If the use or operation of the OXYLATOR[®] EMX is unclear, contact your dealer or agent for clarification.

- The OXYLATOR[®] EMX is a resuscitation management system and should not be used as an unattended automatic ventilator.

- When several OXYLATOR[®] EMX are cleaned simultaneously, assure that the serial number on the valve (8) and the pressure release selector (10) match when reassembling the unit. See Section 5, Cleaning and Disinfecting, pages 12 & 13.

SECTION 2...

TECHNICAL DESCRIPTION AND FEATURES

Description:

The OXYLATOR[®] EMX is an oxygen powered resuscitator/ inhalator which requires no power source (i.e. battery) other than the supply of compressed oxygen in an appropriate cylinder or wall outlet.

The oxygen supply hose of the OXYLATOR[®] EMX should be connected to its pressurized source supplying a minimum constant flow of 30 litres per minute and between 45 psig to 80 psig or 3.0 bar to 5.5 bar. During the continuous cycling mode, the inspiratory flow of oxygen will be initiated upon complete, continuous depression of the OXYGEN RELEASE BUTTON. A sensing chamber in the OXYLATOR[®] EMX allows airway pressure to increase to the maximum limit set, at which point the system shuts off the inspiratory flow, allowing passive exhalation to take place.

Upon sensing the completion of the exhalation phase, the valve automatically resets and allows the inspiratory flow to start a new cycle.

Cycling continues as long as required, provided the OXYLATOR[®] EMX is connected to pressurized oxygen and its OXYGEN RELEASE BUTTON is continuously, fully depressed.

The inhalation mode is activated by rotating the INHALATOR KNOB counterclockwise allowing the oxygen flow to be mixed with ambient air with a patient's own inspiratory effort. The flow in the inhalation mode vents out of the valve and does not subject the patient's airway to any pressurization, permitting patients to breathe unassisted.

If a return to automatic cycling mode is needed, full and continuous depression of the OXYGEN RELEASE BUTTON is required. This automatically overrides the inhalation mode.

Gauge Port (Optional):

A gauge (optional) can be connected to the OXYLATOR[®] EMX at the gauge port connection (19) to verify pressure readings in the airway.

Features:

- Meets ISO 32873/74228, Resuscitators Intended for Use with Humans
- Meets American Heart Association Guidelines 2000 for Cardiopulmonary Resuscitation and Emergency Cardiovascular Care. Part 6: Advanced Cardiovascular Life Support, Section 3: "Adjuncts for Oxygenation, Ventilation, and Airway Control"
- Extremely light-weight, impact resistant and durable
- Simple to learn
- Easy to use
- Single use, quick change filter element
- Few moving parts, minimal maintenance required
- Adjustable airway pressure limiting from 20 cm to 45 cm of H₂O
- Constant maximum flow rate of 30 litres per minute
- Manual and continuous cycling
- Built-in inhalator capability
- Compatible with oxygen supply tanks and regulators supplying between 45 and 80 psig inlet pressure and constant minimum flow rate of 30 litres per minute
- Hold-down oxygen release mechanism
- PEEP capability
- Eliminates the risk of "air trapping" or "stacked breath"
- FIO₂ of 1.0 during resuscitation
- Oxygen powered, no waste of O₂ supply for operation
- Audible and visual indication of airway obstruction

OXYLATOR[®] EMX COMPONENTS

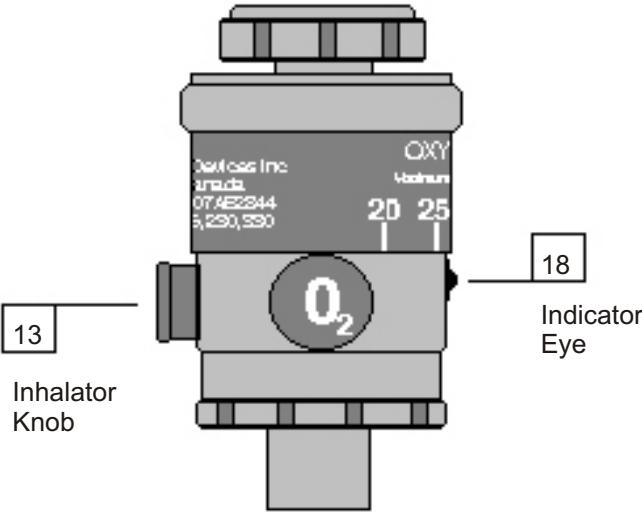
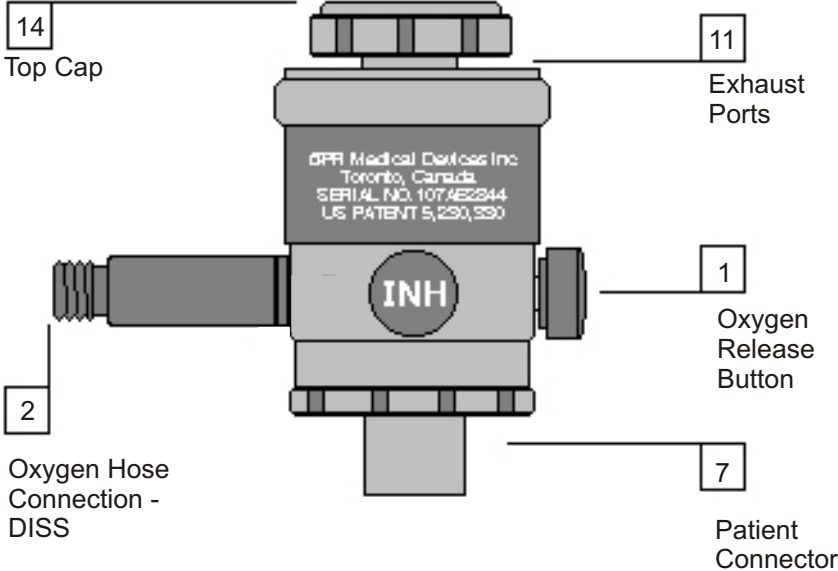

OXYLATOR[®] EMX COMPONENTS

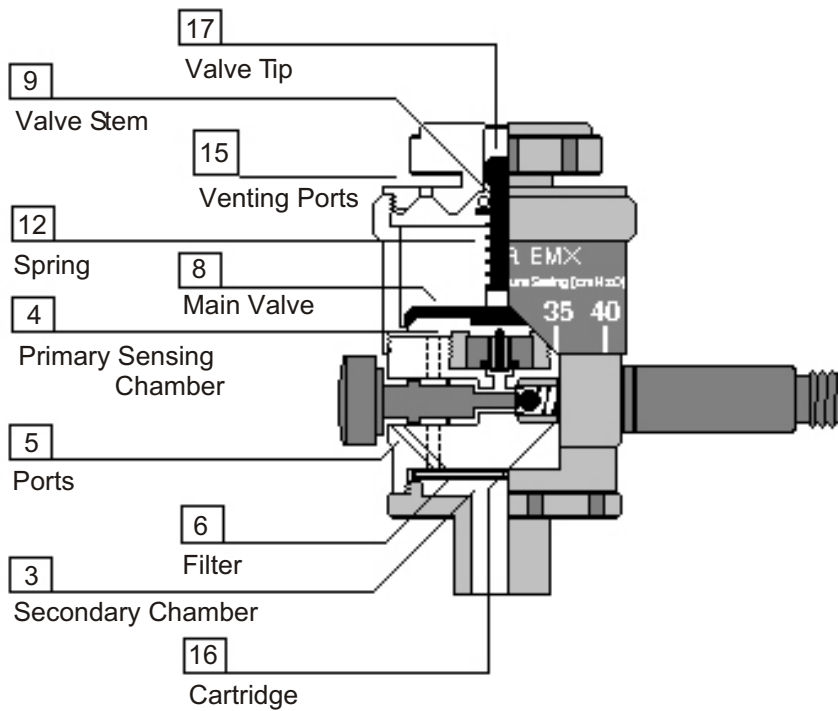
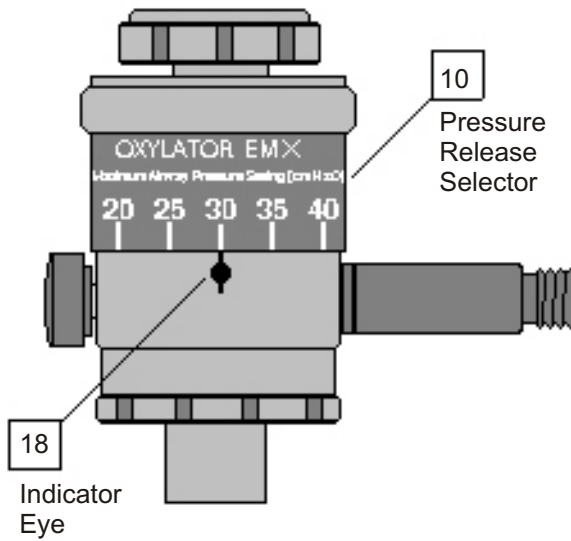

SECTION 3...

FOUR MODES OF OPERATION OF THE OXYLATOR[®] EMX

- 1. MANUALLY ACTIVATED CYCLE FOR NON BREATHING PATIENT -**
The inhalator knob (13) is closed. Inspiratory flow can be initiated for a single cycle by depressing the oxygen release button (1) and holding it down until the OXYLATOR[®] EMX releases at the end of the inspiratory phase, or until chest expansion is considered sufficient for adequate ventilatory exchange and the oxygen release button (1) is let go. Passive exhalation will then take place. The inspiratory phase should be restricted to 2 seconds in an adult and 1 second in a child. The level of pressure release is set by rotating the pressure release selector (10) to the desired value. A new inspiratory cycle can then be initiated by depressing the oxygen release button (1) once again upon completion of exhalation. **This mode will not maintain a baseline pressure (PEEP) and upon complete exhalation the airway pressure will be at 0 cm H₂O.** The OXYLATOR[®] EMX will cycle as in "continuous mode" if the oxygen release button (1) is held depressed constantly as in mode 2.
- 2. CONTINUOUS CYCLE WITH BASELINE PRESSURE (PEEP) FOR NON BREATHING PATIENT - (should only be engaged when the inspiratory time does not exceed 2 seconds in an adult or 1 second in a child)**
The inhalator knob (13) is closed. The system will cycle continuously when the oxygen release button (1) is either continually depressed or held down and then rotated clockwise to seal and activate oxygen flow. This function overrides the inhalation mode automatically. The OXYLATOR[®] EMX will cycle from an inspiratory to expiratory cycle maintaining positive airway pressure throughout the cycle with a baseline pressure (PEEP) value of 2 to 4 cm H₂O. The system will end the inspiratory cycle upon reaching the preset maximum airway pressure level indicated by the pressure release selector (10). This allows unassisted passive exhalation to take place until the expiratory flow diminishes to a level of 2 to 4 cm H₂O PEEP. Then, OXYLATOR[®] EMX will automatically start a new inspiratory cycle. When an operator observes an abnormally long inspiratory phase (greater than 2 seconds in an adult or greater than 1 second in a child), the OXYLATOR[®] EMX should only be used in manually activated cycles. See mode 1.
- 3. MANUALLY ACTIVATED CYCLE WITH BASELINE PRESSURE (PEEP) FOR NON BREATHING PATIENT -** system will maintain a baseline pressure (PEEP) if the inhalator knob (13) is opened counter-clockwise and the OXYLATOR[®] EMX is operated as in mode 1. This will provide a baseline pressure (PEEP) of 2 to 4 cm H₂O.
- 4. INHALATION OF OXYGEN ENRICHED AMBIENT AIR FOR BREATHING PATIENT -** system can be used in this mode by rotating the inhalator knob (13) counter-clockwise which will allow the air to be enriched with oxygen as a patient breathes on his/her own. The oxygen release button (1) cannot be in a depressed position in the inhalation mode.

SECTION 4...

OPERATING INSTRUCTIONS



The following instructions are for the proper use of the OXYLATOR[®] EMX. They are to be followed to provide adequate ventilation when attempting Cardio-pulmonary Resuscitation. The user of this device must have knowledge of CPR techniques. The instructions deal strictly in the proper use of the device.

1. The OXYLATOR[®] EMX hose must be connected to the available oxygen supply, a wall outlet or a pressurized cylinder.
2. When using a pressurized cylinder, open main valve and ensure regulator indicates a reading of between 40 psig and 80 psig; adjust if necessary.
3. Attach suitable mask or endotracheal tube to patient connection (7), make sure mask is rotated into proper position so that an effective seal can be achieved.
4. Ensure inhalator knob (13) is fully closed, and depress oxygen release button (1) briefly to test for oxygen flow.
5. Rotate maximum airway pressure release selector (10) to desired setting simply by aligning pressure value with the indicator eye (18). The pressure can be adjusted from 20 to 45 cm H₂O. It should be initially set at 20 cm H₂O and increased if the operator in his or her opinion determines that the patient needs greater airway pressure. When used with an endotracheal tube, select a maximum airway pressure of 30 cm H₂O to start, then adjust as required.
6. After positioning person and establishing a proper airway, place mask on person's face so as to achieve a complete seal with one hand; using the other hand, depress oxygen release button (1) completely while maintaining mask seal against the person's face. Hold down oxygen release button (1) FIRMLY, or if appropriate, depress, then turn oxygen release button (1) clockwise for continuous oxygen flow. The unit will start cycling continually. OXYGEN RELEASE BUTTON (1) MUST BE HELD MANUALLY DEPRESSED OR KEPT IN LOCKED-IN POSITION AT ALL TIMES FOR CONTINUOUS CYCLING.



CAUTION; WITHOUT A PROPER MASK SEAL THE DEVICE CANNOT CYCLE. A NON-CYCLING DEVICE INDICATES THAT IMPROVEMENT IN AIRWAY MANAGEMENT INCLUDING A PROPER MASK SEAL IS NEEDED.

7. An audible, rapid "clicking" or buzzing sound indicates airway obstruction, STOP!, take necessary steps to clear airway, then reposition person to continue. REPEAT step # 6. An obstruction is also confirmed by observing the rapid movement of the valve tip (17) of the main valve (8).
8. A natural breathing pattern will ensue as the OXYLATOR[®] EMX continually cycles. Ensure that the inspiratory phase does not exceed 2 seconds in an adult or 1 second in a child at any maximum airway pressure setting selected. Switch to manual mode if necessary. see page 10.
9. To stop flow of oxygen, let go of the oxygen release button (1) or, if oxygen release button (1) is in locked-in position, rotate it counter-clockwise.
10. If the OXYLATOR[®] EMX stops cycling during continuous cycling, release the OXYGEN RELEASE BUTTON (1) and restart after increasing the pressure by rotating the PRESSURE RELEASE SELECTOR (10) by 5 cm H₂O. In some patients, higher cycling pressures are required to overcome increased airway resistance.

SECTION 5...

CLEANING AND DISINFECTING

The components of the OXYLATOR[®] EMX are made from acetal, aluminum and stainless steel. This enables the unit to be cleaned and disinfected routinely after each use. The OXYLATOR[®] EMX must be cleaned, disinfected and the filter replaced after each use.

CLEANING THE OXYLATOR[®] EMX.

1. Separate the OXYLATOR[®] EMX from oxygen hose connection (2).
2. Detach patient connection (7) by rotating its knurled rim in a counter-clockwise direction.
3. Remove and DISCARD the USED FILTER (6) from its place in the patient connection (7).
4. Detach top cap (14) by unscrewing in a counter-clockwise direction; pull out main valve (8) from its chamber.
5. Use a mild soap solution to wash out the four components. Then rinse the four components thoroughly with distilled water.
6. Wipe off the water from all components. Firmly tap the components of the unit against the palm of the hand and wipe off the water. Perform for both ends of the valve body, the main valve (8), top cap (14) and the patient connection (7). Repeat this step as necessary until no water droplets are observed.
7. Insert main valve (8) into its chamber and screw on top cap (14) clockwise. **DO NOT OVERTIGHTEN! HAND-TIGHTEN ONLY.** Assure that serial number on main valve (8) is identical to serial number on the pressure release selector (10) when cleaning more than one OXYLATOR[®] EMX at a time.
8. Attach hose to oxygen hose connection (2) by hand. Depress oxygen release button (1) to check for flow. Cover the patient connection end (7) of the valve body with the palm of the hand and depress oxygen release button (1) for a short burst to clear away any trapped water residue. Blot any resulting water droplets. Remove top cap (14) and main valve (8) and blot out any visible liquid in the valve body, on the main valve (8) and top cap (14). Repeat this step of blowing oxygen/drying until no moisture is visible in the main body, the main valve (8) and top cap (14) and that all components are dry. Reassemble main body, main valve (8) and top cap (14).
9. Insert a new filter (6) into its position in patient connection (7). Screw patient connection (7) clockwise onto unit. ! **⚠ DO NOT OVERTIGHTEN! HAND-TIGHTEN ONLY.**
10. Remove hose connection from pressure source.

DISINFECTING THE OXYLATOR[®] EMX.

1. Follow steps 1 through 4 above, wash out and rinse the four components, then disinfect components using a disinfecting solution; or boiling water. Then rinse the four components thoroughly again with distilled water.
2. Continue with steps 6 to 10 above.

INSTRUCTIONS FOR CLEANING THE OXYLATOR[®] EMX
AFTER CONTAMINATION BY VOMITUS.

1. Remove mask from patient connection (7).
2. Detach patient connection (7) by rotating its knurled rim in counter-clockwise direction.
3. Remove and discard the used filter (6) from its place in the patient connection (7).
4. If necessary, wipe clean inside secondary chamber (3), depress the oxygen release button (1) to blow out any possible materials that may have penetrated through the particle filter (6), wipe secondary chamber (3), clean again if necessary.
5. Insert new filter (6) into its position in patient connection (7). Screw patient connection (7) clockwise onto unit. DO NOT OVERTIGHTEN! Press the oxygen release button (1) for a quick burst of oxygen to check for flow.
6. Attach mask (new or cleaned) to patient connection (7).
7. The OXYLATOR[®] EMX is ready for use again.

NOTE: A filter change should normally take approximately 20 seconds.

DISASSEMBLY FOR CLEANING THE OXYLATOR[®] EMX

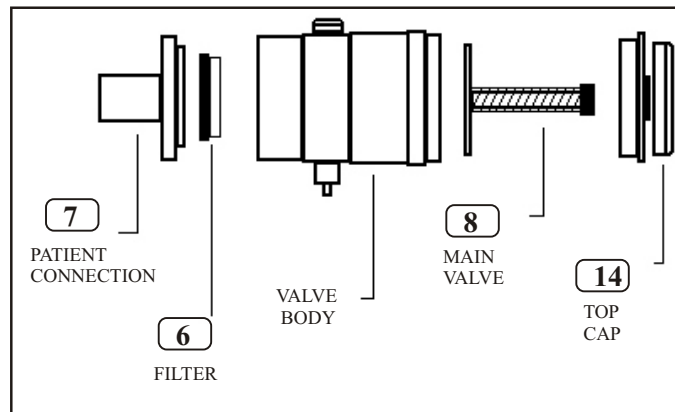

*****WARNING*****

ENSURE THAT THE OXYLATOR[®] EMX IS DRY BEFORE EXPOSING THE UNIT TO FREEZING CONDITIONS. LIQUID OR WATER IN VALVES MAY CAUSE THEM TO MALFUNCTION IN FREEZING TEMPERATURES. DO NOT AT ANY TIME USE GREASE OR OIL FOR ANY PURPOSE ON THE OXYLATOR[®] EMX. DO NOT USE THE UNIT IN OXYGEN DEFICIENT ATMOSPHERES OR NEAR OPEN FLAMES. DO NOT SMOKE WHILE USING THE OXYLATOR[®] EMX OR ANY OTHER OXYGEN EQUIPMENT. DO NOT AUTOCLAVE THE OXYLATOR[®] EMX.

SECTION 6...

MAINTENANCE

Due to the revolutionary new design and functional characteristics of the OXYLATOR[®] EMX, minimal maintenance is required!

The OXYLATOR[®] EMX will function for millions of cycles without requiring any form of maintenance. However, the unit should be periodically subjected to short "bursts" of a few seconds (1 - 2 seconds). This can be accomplished simply by depressing the oxygen release button (1) with the unit connected to its pressure supply.

If for ANY REASON the unit malfunctions, remove the device from service and contact your sales person, distributor, or agent for help. If the problem cannot be solved, the device should be returned to CPR MEDICAL DEVICES INC. or its distributor in your territory for repair or replacement.

DO NOT DISMANTLE OR ATTEMPT TO REMOVE ANY COMPONENTS OTHER THAN THOSE REQUIRED FOR ROUTINE CLEANING! ANY TAMPERING WITH THE OXYLATOR[®] EMX WILL VOID THE WARRANTY AND MAY CAUSE THE UNIT TO MALFUNCTION!

SECTION 7...

WARRANTY

CPR MEDICAL DEVICES INC. warrants this product to be free from any defects in material and workmanship for a period of five (5) years from the date of purchase to the initial purchaser. Warranty card must be completed to validate warranty.

The warranty will be void if any filters are used other than the ones supplied by CPR MEDICAL DEVICES INC. or its distributors.

All shipping charges for returned goods should be prepaid. Upon inspection and evaluation of the returned unit by CPR MEDICAL DEVICES INC. or its distributors, the OXYLATOR[®] EMX will be either replaced or repaired to conform to the required standards.

Any evidence of tampering or disassembly of the valve for any purpose other than routine cleaning and maintenance shall void this warranty.

CPR MEDICAL DEVICES INC. shall in no event be liable for any consequential damages, nor for loss, damage or expenses directly or indirectly arising from the use of the OXYLATOR[®] EMX.

SECTION 8...

SPECIFICATIONS

Model	- OXYLATOR [®] EMX
Weight	- 0.25 kg; 0.55 lbs
Dimension dia * length	- 2.25 in. * 4.25 in., 57mm * 108mm
Material of housing	- Acetal
Required source pressure	- between 45 psig to 80 psig, or between 3.0 bar and 5.5 bar
Required flow (source)	- min. 30 litres per minute
Dead Space	- 20 millilitres
Inspiratory flow rate	- 30 litres per minute (max)
Minute volume delivered	- 10 to 12 litres per minute in auto mode
Min. time of oxygen supply	- Cylinder vol. divided by 12 l/min
I : E ratio	- 1 : 1 to 1 : 2 or manually controlled
PEEP	- 2 to 4 cm H ₂ O in auto mode
Ventilatory frequency	- Auto-adjusting to lung capacity in auto mode
Range of pressure relief	- 20 to 45 cm H ₂ O , 14.5 to 35 mm Hg
Expiratory resistance	- approximately 5 cm H ₂ O in manual mode
Suitable body mass range	- 10 kg+, 22 lbs +
Inhalator flow	- 0 to 15 litres per minute of 100% O ₂
Oxygen concentration	- 100% during resuscitation mode
Filter	- Single use, disposable
Mask/airway connections	- 15mm internal / 22mm external
Usage temperature range	- - 30 C - + 60 C, - 22 F - +140 F
Storage temperature range	- - 40 C - + 70 C, - 40 F - +158 F
Obstructed airway warning	- Rapid cycling, audible and visual
Oxygen inlet connection	- DISS, ISO standard or quick connect

NOTE: Data on functional characteristics can fluctuate under varying conditions. Please OBSERVE INSTRUCTIONS AND WARNINGS in this operating manual.